

TUNING INSTRUCTIONS

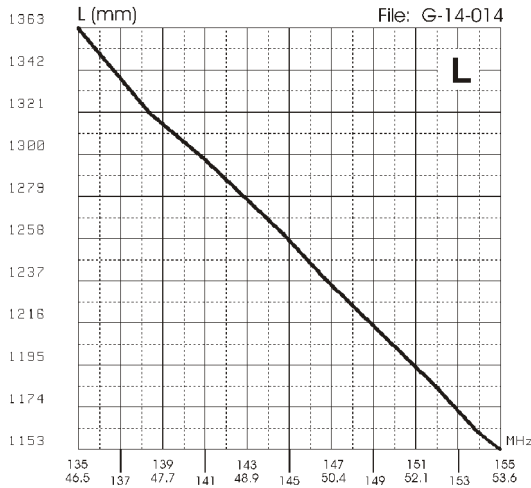

SMA 47/135

TYPICAL TUNING DIAGRAM vs FREQUENCY



TYPICAL TUNING DIAGRAM vs FREQUENCY

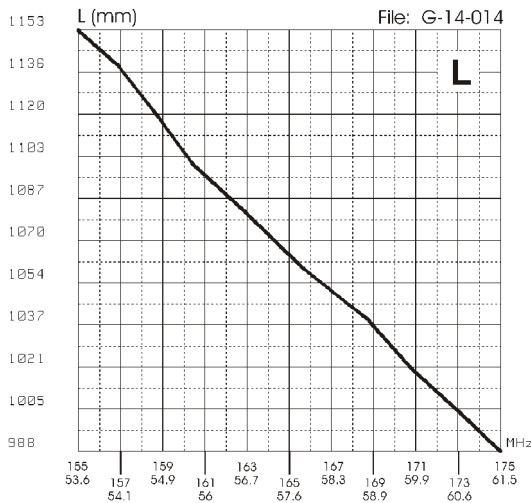

TYPICAL S.W.R. RESPONSE

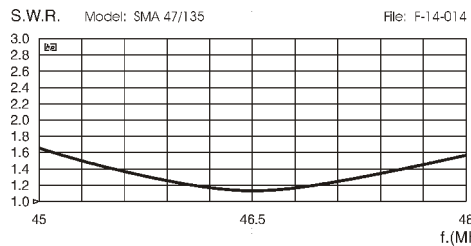

TYPICAL S.W.R. RESPONSE

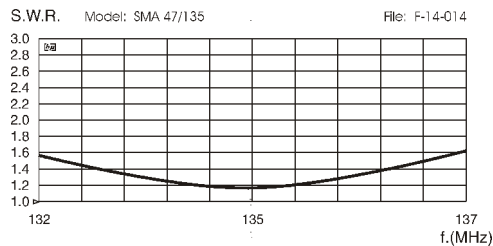

SM 48/140

SMA 47/135

6m & 2m Dual band VHF Mobile Antennas



SM 48/140



SMA 47/135

Installation Manual

DESCRIPTION

Dual band VHF vehicular antennas working on 6m band and 2m band by means of the attached cutting diagram. SM is made of tapered black fiberglass whip while SMA is made of tapered 17/7 PH stainless steel of very high flexibility. Both models are supplied with a strong stainless steel spring. Available with "S" or "SL" mount on request.

SPECIFICATIONS

Electrical Data

Type : 1/4 Base Loaded for 46.5...61.5 MHz band
 : 5/8 for 135...175 MHz band
 Frequency Range : SM from 47.5 to 60.5 MHz & from 140 to 175 MHz
 : SMA from 46.5 to 61.5 MHz & from 135 to 175 MHz
 both models tunable by cutting

Impedance : 50
 Radiation : Omnidirectional
 Polarization : Linear Vertical
 Gain : 0 dB ref. to a 1/4 whip for 46.5...61.5 MHz band
 : 2 dB ref. to a 1/4 whip for 135...175 MHz band
 Bandwidth @ SWR 1.5 : SM 2 MHz @ 47.5 MHz; 2.8 MHz @ 140 MHz
 : SMA 2.5 MHz @ 46.5 MHz; 3.4 MHz @ 135 MHz
 SWR @ res. freq. : 1.3 both bands, both models
 Max Power : 100 Watts
 Standard Mount : "S", mounting hole 19 mm, cable 5m RG 58
 Alternative Mount : "SL", mounting hole 19 mm, cable 5m RG 58

Mechanical Data

Materials : SM Fiberglass, Stainless Steel, Nylon, Chromed Brass
 : SMA Stainless Steel 17/7 PH, Nylon, Chromed Brass
 Height (approx.) : SM 1340 mm
 : SMA 1505 mm
 Weight (approx.) : 550 gr

MOUNT INSTALLATIONS

"S" Mount

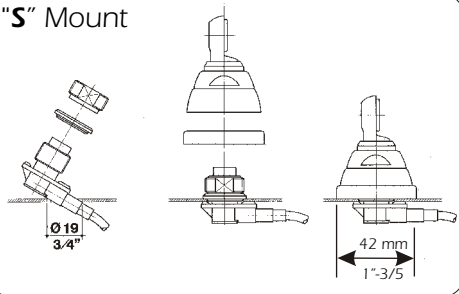

"SL" Mount

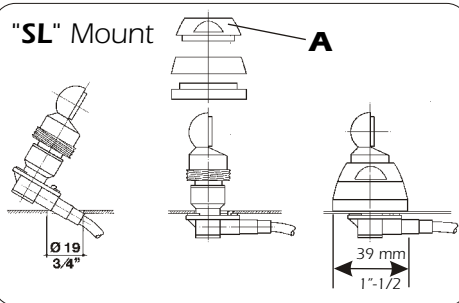

"SL" MOUNT REMARK: Be careful during installation do not use too much strenght but tighten the metal ring **A** by means of the suitable tool. **TIGHTENING TORQUE: 4 Nm ± 10%**

PRECAUZIONE PER BASE "SL": Porre attenzione durante l'installazione. Non serrare con troppa forza ma avvitare l'anello metallico **A** utilizzando la chiave adeguata. **COPPIA DI SERRAGGIO: 4 Nm ± 10%**

TUNING INSTRUCTIONS

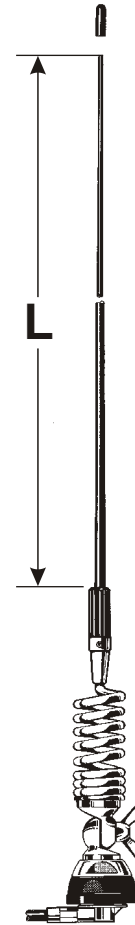

SM 48/140

NOTE:

- Use the curves just as a guide. For fine-tuning please use an SWR-Meter.

TYPICAL TUNING DIAGRAM vs FREQUENCY

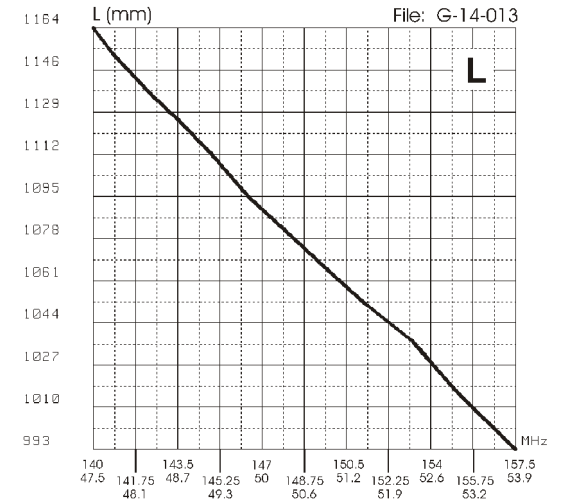

TYPICAL TUNING DIAGRAM vs FREQUENCY

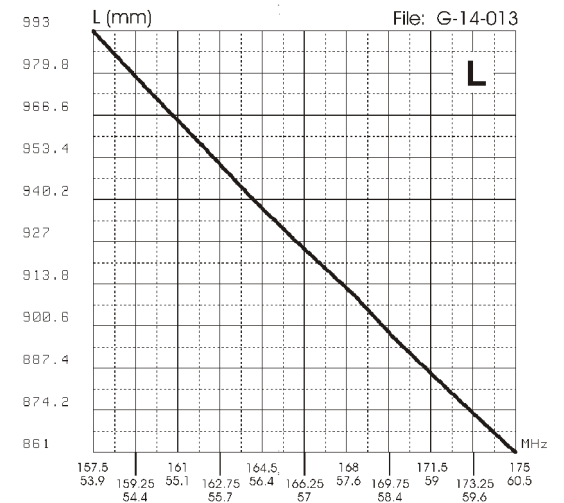

TYPICAL S.W.R. RESPONSE

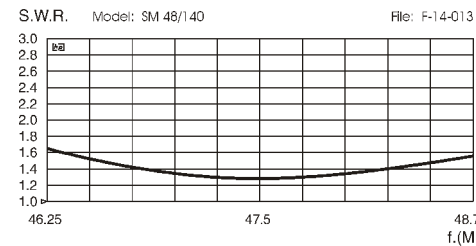

TYPICAL S.W.R. RESPONSE

